



# Valvole rotative DC\_ - Rotary valves DC\_

## Caratteristiche - Design features

**Trasmissione diretta** o a catena  
*Direct drive or chain drive*

**Rotore chiuso con 6/8 pale saldate**,  
estremità delle pale sostituibili  
*Fabricated 6/8 vanes closed end rotor,*  
*replaceable blade tips*

**Facile manutenzione**  
**grazie alla semplicità costruttiva.**  
Coperchi, rotore e trasmissione possono essere  
facilmente smontati per ispezioni o pulizia  
*Easy maintenance due to simple construction.*  
*End covers, rotor and drive can be easy dismantled*  
*for inspection or cleaning*

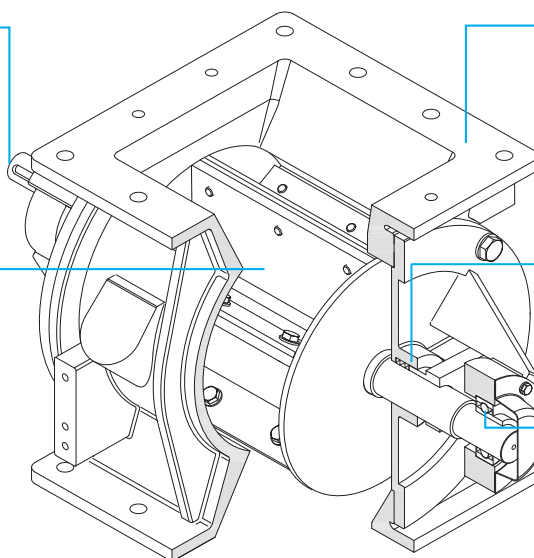

**Robusto corpo in fusione**  
con entrata ed uscita quadrate  
di grandi dimensioni  
*Rugged cast body*  
*with large square inlet and outlet*

**Tenuta con prebaderna**  
*Packing gland type seals*

**Cuscinetti montati esternamente**,  
separati dal prodotto tramite lo spazio  
esterno tra tenuta e cuscinetto  
*Outboard mounted ball bearings,*  
*separated from product by outlet space*  
*between shaft seal and bearing*

## Dati tecnici - Technical data

**Diagramma delle portate**  
*Capacity diagram*

Riempimento al 100%  
*Filling Efficiency 100%*

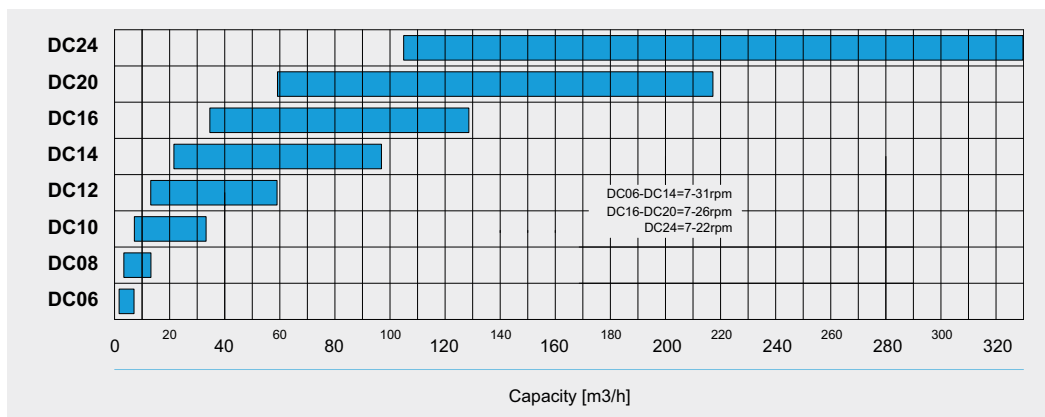

## Versioni - Versions

**Versioni**  
*Versions*



- **Versioni ATEX 2014/34/EU**  
Gruppo II, Zona 1/21, Cat.2GD  
Gruppo II, Zona 0/20, Cat.1GD  
**Versions ATEX 2014/34/EU**  
Group II, Zone 1/21, Cat.2GD  
Group II, Zone 0/20, Cat.1GD

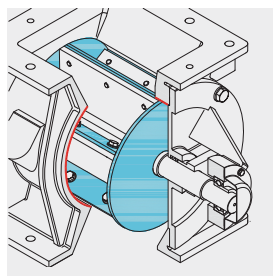

- **Versioni antiusura**,  
differenti soluzioni e materiali  
con più livelli di protezione  
**Wear resistance versions,**  
*various designs and materials*  
*with different wear protection*  
*levels*

## Rotori ed accessori - Rotors and accessories

### Rotori Rotors

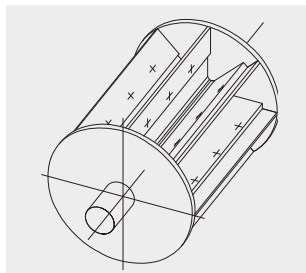

- Rotore DS (Standard)**  
 Rotore chiuso con estremità delle pale sostituibili  
**Rotor DS (Standard)**  
 Closed end rotor with replaceable blade tips

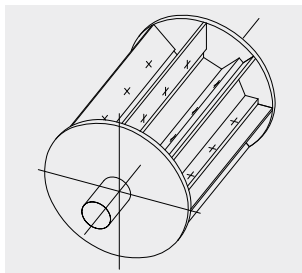

- Rotore GS**  
 Rotore chiuso parzialmente riempito con estremità delle pale sostituibili  
**Rotor GS**  
 Closed end partially filled rotor with replaceable blade tips

### Accessori Accessories

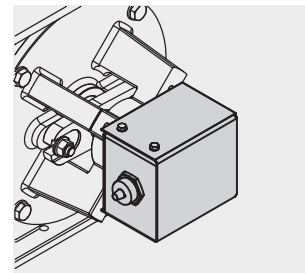

- Controllo di rotazione**  
**Motion indicator**

## Designazione del tipo - Type designation

### Esempio Example

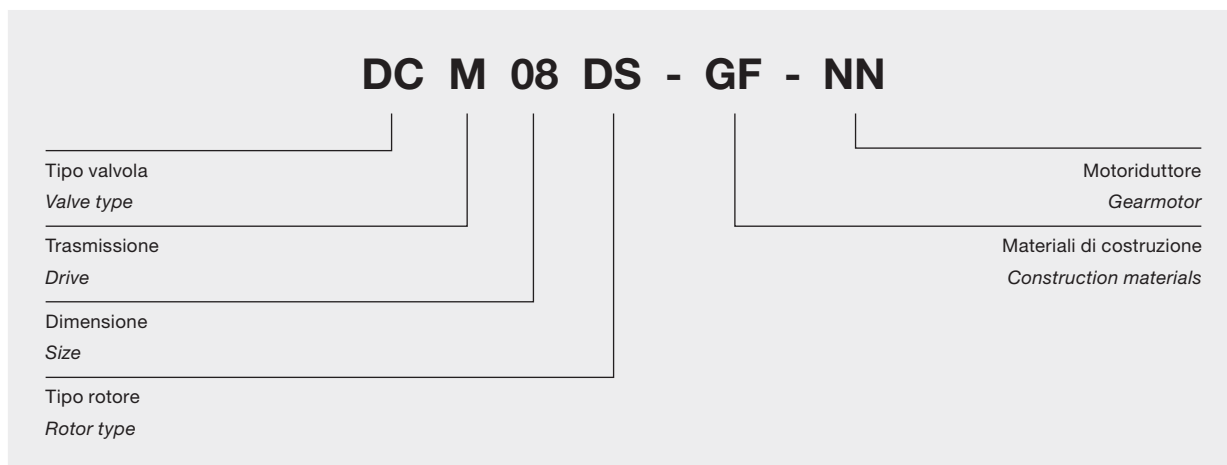

# Valvole rotative DCM\_ - Rotary valves DCM\_

## Dimensioni - Dimensions

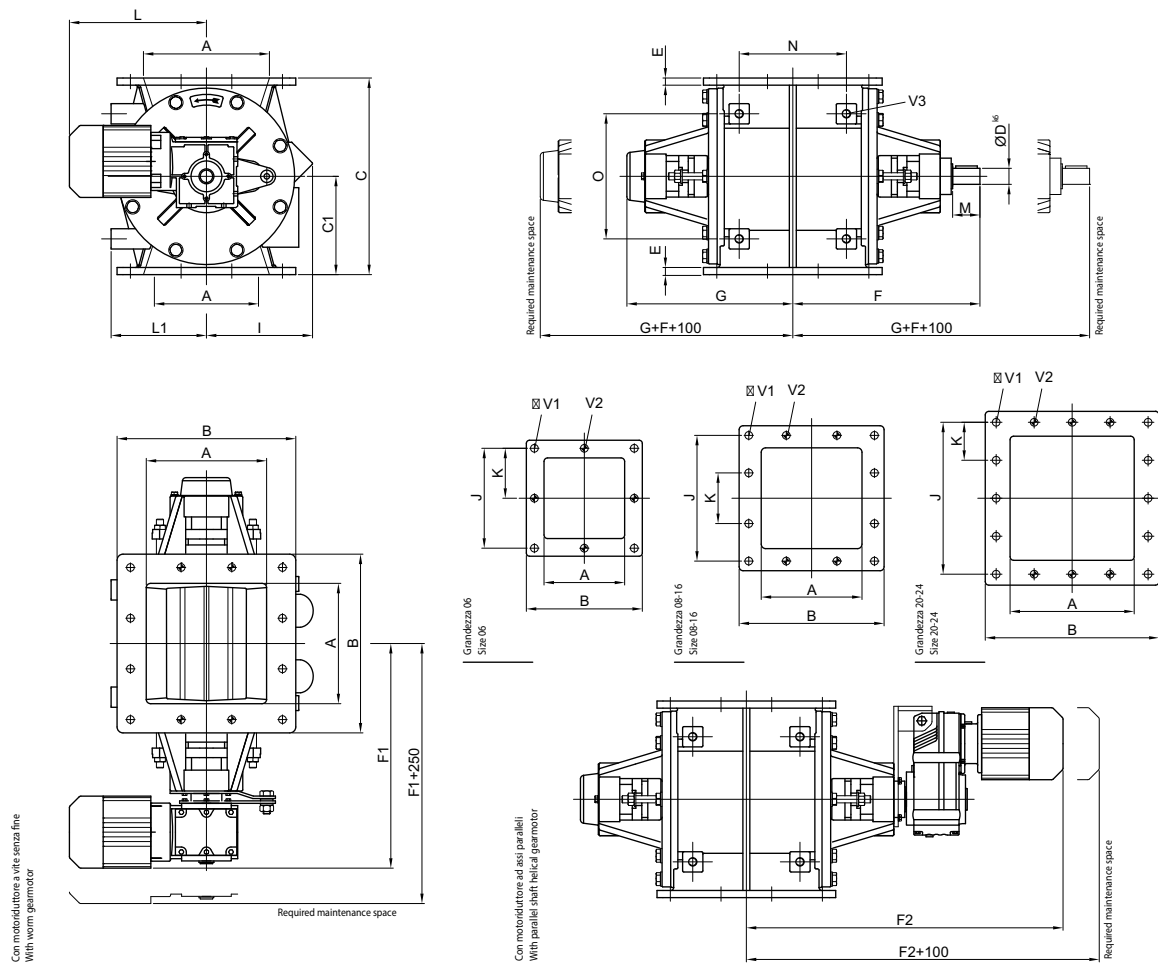

	Ltr/rev Ltr/giro	A	B	C	C1	Ø D <sup>k6</sup>	E	F	F1 <sup>2)</sup>	F2 <sup>2)</sup>	G	I
DCM06	3,5	150	260	260	130	25	12	272	342	500	221	135
DCM08	7	200	292	330	165	30	12	294	362	550	240	152
DCM10	18	250	350	400	200	30	16	320	402	625	266	191
DCM12	32	300	430	490	245	35	16	400	---	724	337	231
DCM14	52	350	480	560	280	40	20	441	---	785	375	290
DCM16	82	400	530	645	322,5	40	20	480	---	855	415	332
DCM20	140	500	650	740	370	50	20	633	---	1070	470	346
DCM24	250	600	750	940	470	60	25	709	---	1190	545	435

	L <sup>2)</sup>	L1	M	N	O	J	K	Ø V1	V2	V3	kg <sup>1)</sup>
DCM06	314	124	60	172	162	210	105	14	M12	M12	70
DCM08	314	176	60	112	190	255	85	14	M12	M16	115
DCM10	345	194	60	261	280	306	102	14	M12	M16	160
DCM12	---	236	70	304	320	390	130	14	M12	M16	260
DCM14	---	292	70	360	340	432	144	14	M12	M20	390
DCM16	---	344	70	362	340	480	160	18	M16	M20	450
DCM20	---	356	165	403	400	600	150	18	M16	M20	660
DCM24	---	445	188	430	500	672	168	18	M16	M24	1200

1) Peso approssimativo / Weight approx.  
2) Misure approssimative / Measurements approx.

# Valvole rotative DCT\_ - Rotary valves DCT\_

## Dimensioni - Dimensions

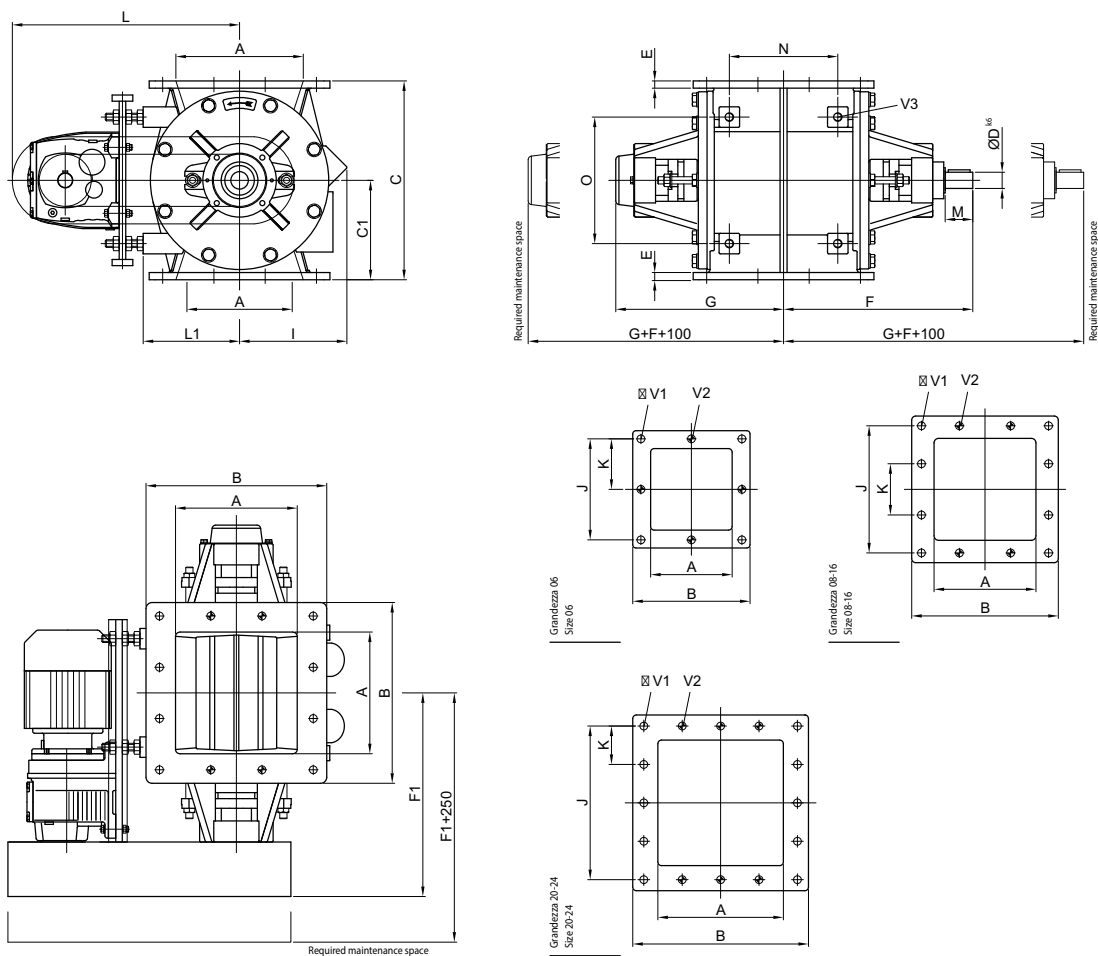

	Ltr/rev Ltr/giro	A	B	C	C1	Ø D <sup>k6</sup>	E	F	F1	G	I
DCT06	3,5	150	260	260	130	25	12	272	297	221	135
DCT08	7	200	292	330	165	30	12	294	317	240	152
DCT10	18	250	350	400	200	30	16	320	342	266	191
DCT12	32	300	430	490	245	35	16	400	409	337	231
DCT14	52	350	480	560	280	40	20	441	438	375	290
DCT16	82	400	530	645	322,5	40	20	480	478	415	332
DCT20	140	500	650	740	370	50	20	538	560	470	346
DCT24	250	600	750	940	470	60	25	609	624	545	435

	L <sup>2)</sup>	L1	M	N	O	J	K	Ø V1	V2	V3	kg <sup>1)</sup>
DCT06	375	124	60	172	162	210	105	14	M12	M16	78
DCT08	444	176	60	180	210	255	85	14	M12	M16	120
DCT10	444	194	60	261	280	306	102	14	M12	M16	175
DCT12	522	236	70	304	320	390	130	14	M12	M16	280
DCT14	590	267	70	360	340	432	144	14	M12	M20	365
DCT16	668	310	70	362	340	480	160	18	M16	M20	465
DCT20	758	356	70	403	400	600	150	18	M16	M20	680
DCT24	897	445	80	430	500	672	168	18	M16	M24	1220

1) Peso approssimativo / Weight approx.  
2) Misure approssimative / Measurements approx.



## Altri prodotti YOUNG-MASSA - Other YOUNG-MASSA products



**LDC\_**  
Valvole rotative – 0,1 bar  
*Rotary valves – 0,1 bar*



**LDT\_**  
Valvole rotative – 1 bar  
*Rotary valves – 1 bar*



**LDR\_**  
Valvole rotative DIN PN10 – 1 bar  
*Rotary valves DIN PN10 – 1 bar*



**LBT\_**  
Valvole rotative a flusso attraversato – 1 bar  
*Blow-thru Rotary valves – 1 bar*



**LSE\_**  
Valvole rotative per granuli – 1 bar  
*Rotary valves for pellets – 1 bar*



Versioni a smontaggio rapido  
*Fast opening versions*



Versioni con guide di estrazione  
*Versions with supporting bars*

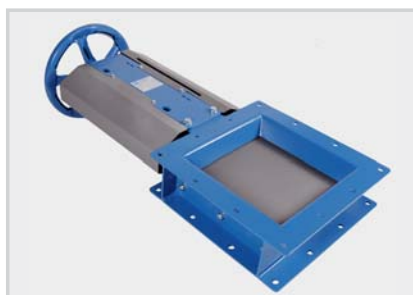

**VP\_, VPH\_**  
Valvole a ghigliottina  
*Slides Valves*



**SA\_**  
Valvole a doppio clapet  
*Double flap gate valves*

OVER  
**40**  
Years of service



**Ex**  
2014/34/EU

**YM**  
**YOUNG-MASSA**

**YOUNG-MASSA Srl**

Via S. Maria, 5  
20873 Cavenago Brianza (MB) - Italia

Tel: +39 0295019613

Fax: +39 0295019413

info@youngmassa.it

www.youngmassa.it